

# LI200P0-Q25LM0-LIU5X3-H1151

## Inductive Linear Position Sensor

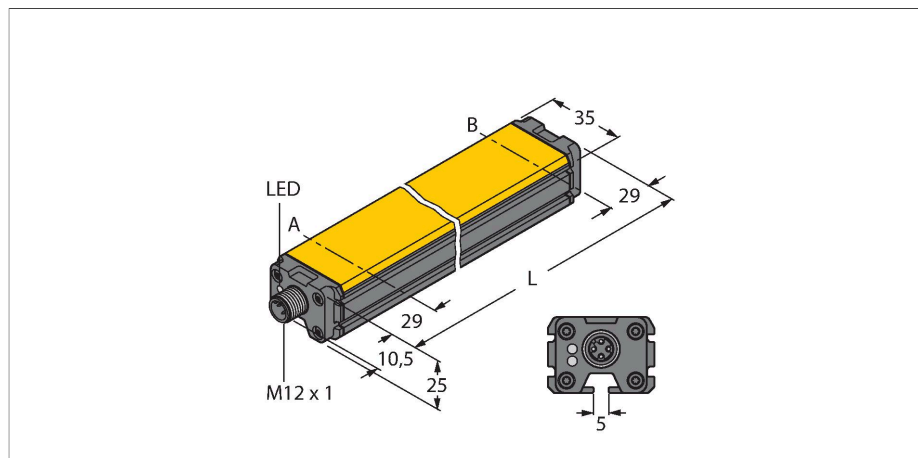

### Features

- Rectangular, aluminium / plastic
- Versatile mounting possibilities
- LED indicates measuring range
- Immune to electromagnetic interference
- Extremely short blind zones
- Resolution, 12-bit
- 4-wire, 15...30 VDC
- Analog output
- Programmable measuring range
- 0...10 V and 4...20 mA
- M12 x 1 male, 5-pin

### Technical data

<b>Type</b>	LI200P0-Q25LM0-LIU5X3-H1151
Ident. no.	1590002
<b>Measuring principle</b>	Inductive
Measuring range	200 mm
Resolution	0,049 mm/12 bit
Nominal distance	1.5 mm
Blind zone a	29 mm
Blind zone b	29 mm
Repeat accuracy	≤ 0.026 % of full scale
Linearity deviation	≤ 0.1 %f.s.
Temperature drift	≤ ± 0.003 % / K
Hysteresis	not applied
Ambient temperature	-25...+70 °C
Operating voltage	15...30 VDC
Residual ripple	≤ 10 % U <sub>ss</sub>
Isolation test voltage	≤ 0.5 kV
Short-circuit protection	yes
Wire breakage/Reverse polarity protection	yes / yes (voltage supply)
Output function	5-pin, Analog output
Voltage output	0...10 V
Current output	4...20 mA
Load resistance voltage output	≥ 4.7 kΩ
Load resistance, current output	≤ 0.4 kΩ
Sample rate	500 Hz
Current consumption	< 50 mA
<b>Design</b>	Profile,Q25L
Dimensions	258 x 35 x 25 mm

### Wiring diagram

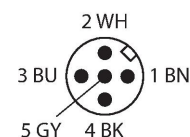
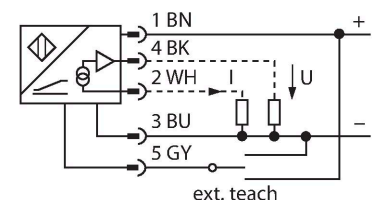

### Functional principle

The measuring principle of linear position sensors is based on RLC coupling between the positioning element and the sensor, whereby an output signal is provided proportional to the position of the positioning element. The rugged sensors are wear and tear-free, thanks to the contactless operating principle. They convince through their excellent repeatability, resolution and linearity within a broad temperature range. The innovative technology ensures a high immunity to electromagnetic DC and AC fields.

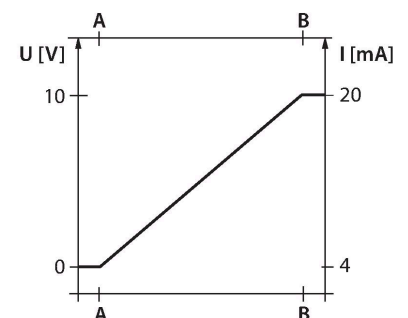

## Technical data

Housing material	Aluminum/plastic, PA6-GF30, Anodized
Active area material	Plastic, PA6-GF30
Electrical connection	Connectors, M12 × 1
Vibration resistance	55 Hz (1 mm)
Shock resistance	30 g (11 ms)
Protection class	IP67
MTTF	138 years acc. to SN 29500 (Ed. 99) 40 °C
<b>Power-on indication</b>	LED, Green
Measuring range display	multifunction LED, green, yellow, yellow flashing

## Mounting instructions

### Mounting instructions/Description

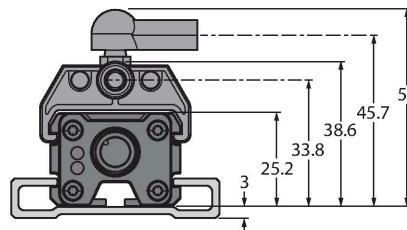
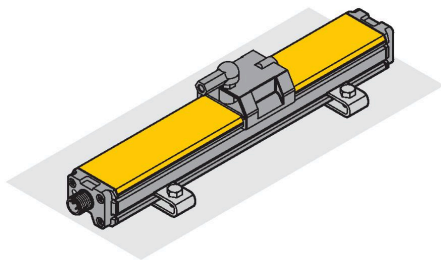

Extensive mounting accessories provide various options for installation. Due to the measuring principle, which is based on the functional principle of an RLC coupling, the linear position sensor is immune to magnetized metal splinters and other interferences.

#### Status display via LED

##### Green:

Sensor is supplied properly

##### LED indicates measuring range

##### Green:

Positioning element is within the measuring range

##### Yellow:

Positioning element is within the measuring range, low signal intensity (e.g. distance too large)

##### Yellow flashing:

Positioning element is outside the detection range

##### Off:

Positioning element is outside the programmed range (only with teachable versions)

#### Teaching

The start and end point of the measuring range are set by pressing the button on the teach adapter. Moreover there is the possibility of inverting the course of the output curve.

Bridge pin 5 and pin 1 for 10 s = factory setting

Bridge pin 5 and pin 3 for 10 s = factory setting inverted

Bridge pin 5 and pin 3 for 2 s = sets start value of measuring range

Bridge pin 5 and pin 1 for 2 s = sets end value of measuring range

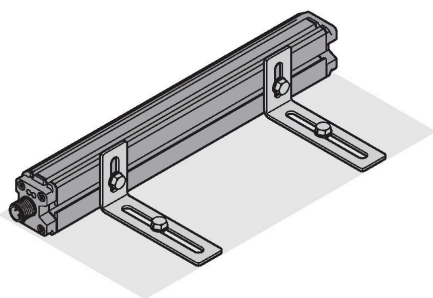

## Accessories

**P1-LI-Q25L**

**6901041**

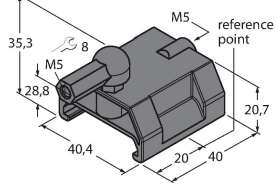

Guided positioning element for linear position sensors LI-Q25L, inserted in the groove of the sensor

**P2-LI-Q25L**

**6901042**

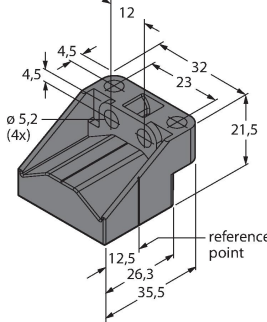

Floating positioning element for linear position sensors LI-Q25L; the nominal distance to the sensor is 1.5 mm; pairing with the linear position sensor at a distance of up to 5 mm or misalignment tolerance of up to 4 mm.

**P3-LI-Q25L**

**6901044**

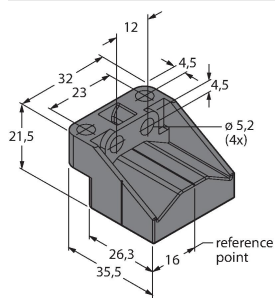

Floating positioning element for Li-Q25L linear position sensors; operational at an offset of 90°; nominal distance to sensor 1.5 mm; pairing with linear position sensor at a distance of up to 5 mm; misalignment tolerance of up to 4 mm

**P6-LI-Q25L**

**6901069**

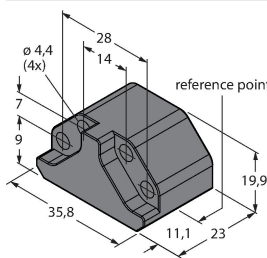

Floating positioning element for linear position sensors LI-Q25L; the nominal distance to the sensor is 1.5 mm; pairing with the linear position sensor at a distance of up to 5 mm or misalignment tolerance of up to 4 mm.

**P7-LI-Q25L**

**6901087**

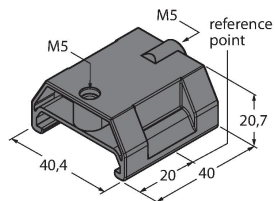

Guided positioning element for linear position sensors LI-Q25L, without ball joint

**M1-Q25L**

**6901045**

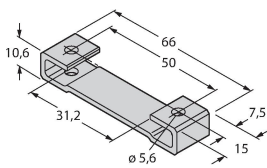

Mounting foot for linear position sensors LI-Q25L; material: aluminum; 2 pcs. per bag

**M2-Q25L**

**6901046**

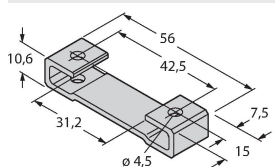

Mounting foot for linear position sensors LI-Q25L; material: aluminum; 2 pcs. per bag

**M4-Q25L**

**6901048**

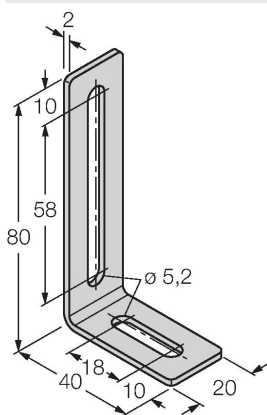

Mounting bracket and sliding block for linear position sensors LI-Q25L; material: Stainless steel; 2 pcs. per bag

**MN-M4-Q25**

**6901025**

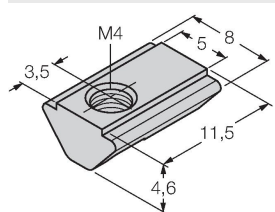

Sliding block with M4 thread for the backside profile of the LI-Q25L; material: galvanized steel; 10 pcs. per bag

**AB-M5**

**6901057**

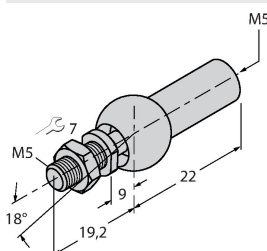

Axial Joint for Guided Positioning Elements

**ABVA-M5**

**6901058**

Axial joint for guided positioning element, stainless steel

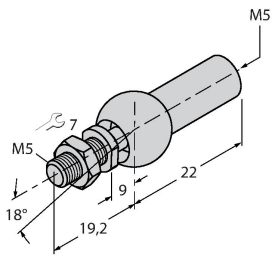

**RBVA-M5**

**6901059**

Angle joint for guided positioning element, stainless steel

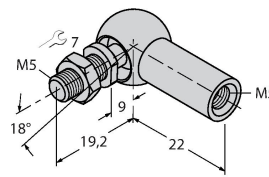

## Accessories

**Dimension drawing**

**Type**

**Ident. no.**

**TX1-Q20L60**

**6967114**

Teach adapter for inductive encoders, linear position, angle, ultrasonic and capacitive sensors

